

INW 01-84_Одноступенчатые компрессоры и насосы

Размеры

страница 1 из 3

серия	A	B	C	D	E	F	G	H	J	K	L	M	N	O	P	Q
INW 01	190	203	72	155	172	242	124	102	101	80	101	108	53	30	G 1"	46
INW 11	213	225	76	155	172	242	124	114	101	80	101	111	52	33	G 1"	46
INW 21 A11	246	247	90	205	230	256	133	128	111	83	108	75	71	39	G 1½"	64
INW 21 H06						219	92		101							
INW 21 H16						256	129		111							
INW 31	261	266	101	206	228	245	129	140	111	83	105	75	71	42	G 1½"	68
INW 41 A01	285	302	115	225	255	269	129	154	120	95	130	70	75	46	G 1½"	68
INW 41 A11						292	156									
INW 41 A21																
INW 41 H06						269	129									
INW 41 H16						292	153									
INW 41 H26																
INW 51 A11	334	337	120	260	295	314	156	175	120	115	155	96	87	48	G 2"	83
INW 51 A21						346	188		128							
INW 51 H06						314	153		128							
INW 51 H16																
INW 51 H26						346	185									
INW 51 H36																
INW 53 A21	334	337	120	260	295	365	191	175	128	115	155	96	87	48	55	83
INW 53 H06					295	334	160		120			96				
INW 53 H16					195	365	191		128			96				
INW 53 H26					275	365	191		128			94				
INW 53 H36					295	365	191		128			96				
INW 61	363	365	120	290	325	353	190	190	156	140	180	76	95	54	G 2"	83
INW 71 H06	382	384	125	290	325	377	185	198	128	140	180	84	109	54	G 2"	83
INW 71 H16																
INW 71 H26						411	190		135							
INW 71 H37						432	211		148							
INW 73	360	366	122	284	325	387	191	197	128	140	180	84	109	54	G 2"	83
INW 73 H37	382	384	125	290	325	432	209	198	148	140	180	84	109	54	G 2"	83

INW 01-84_Одноступенчатые компрессоры и насосы ИНВ

Размеры

страница 2 из 3

серия	ø R	S	U	V	V'	V1	V1'	W	ø X	Y x Z	X - отверстие
INW 01	8,5	2	M6 x 18	-	-	M16 x 1,5	-	29	115	M6 x 20	0°/120°/240°
INW 11	8,5	2	M6 x 18	-	-	M16 x 1,5	-	29	126	M6 x 20	0°/120°/240°
INW 21	10	2,5	M6 x 17	M6 x 1,5	M25 x 1,5	M25 x 1,5	M16 x 1,5		140	M6 x 15	0°/120°/240°
INW 31	12	3	M8 x 17	-	-	-	-		158	M6 x 15	0°/120°/240°
INW 41	12	3	M6 x 19	M6 x 1,5	M25 x 1,5	M25 x 1,5	M16 x 1,5		174	M6 x 15	0°/120°/240°
INW 51	14	4	M8 x 17	M16 x 1,5	M25 x 1,5	M25 x 1,5	M16 x 1,5		200	M8 x 20	0°/120°/240°
INW 53	14	4	M8 x 17	M16 x 1,5	-	M25 x 1,5	M16 x 1,5	29	200	M8 x 20	0°/120°/240°
INW 53 A21	14	4	M8 x 17	M16 x 1,5	-	-	-	29	200	M8 x 20	0°/120°/240°
INW 61	15	4,5								M10 x 20	0°/120°/240°
INW 71 H06	15	4,5					M10 x 20		240	M10 x 20	0°/120°/240°
INW 71 H16											
INW 71 H26				M32 x 1,5	M32 x 1,5	M32 x 1,5	M32 x 1,5				
INW 71 H37											
INW 73											

серия	A	A'	B	B'	B ₁	C	C'	D	E	F	F'	F''	G	H	H'	J	K	L	M	M'
INW 81 H07	451	-	461	509	-	152	-	356	394	433	450	-	230	240	-	148	170	217	124	2
INW 81 H17, H27		-									477	-	247		-	167				
INW 83 H07	451	-	461	509	-	152				449	456	-	230	240	-	148			139	
INW 83 H17, H27		-			-						492	-	247		-	167				
INW 84 H27	500	-	550	-	-	-	336	356	394	589	-	-	247	300	-	167	170	217	-	-
INW 84 H37		-		-	-	336	-			694	-	-	318		-	197			312	-

серия	N	N'	O	ø P	Q	ø R	S	T	U	V	W	ø X	Y+Z	X - отверстие
INW 81 H07	149	-	65	G 2½"	-	15	6	-	-	4 x M32 x 1,5	42	286	M10 x 35	0°/120°/240°
INW 81 H17, H27		-			-			-	-					
INW 83 H07	164	-	65							4 x M32 x 1,5	42			0°/120°/240°
INW 83 H17, H27		-												
INW 84 H27	261	-	125				66			4 x M32 x 1,5	42		M12 x 20	
INW 84 H37	212	-	165							4 x M40 x 1,5	54			

INW 01-84_Одноступенчатые компрессоры и насосы

Размеры

страница 3 из 3

INW 01 > INW 73

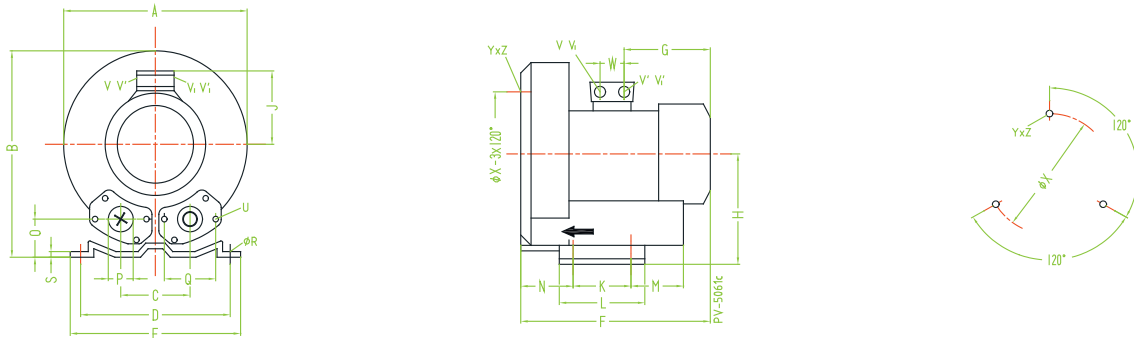

INW 81 > INW 83

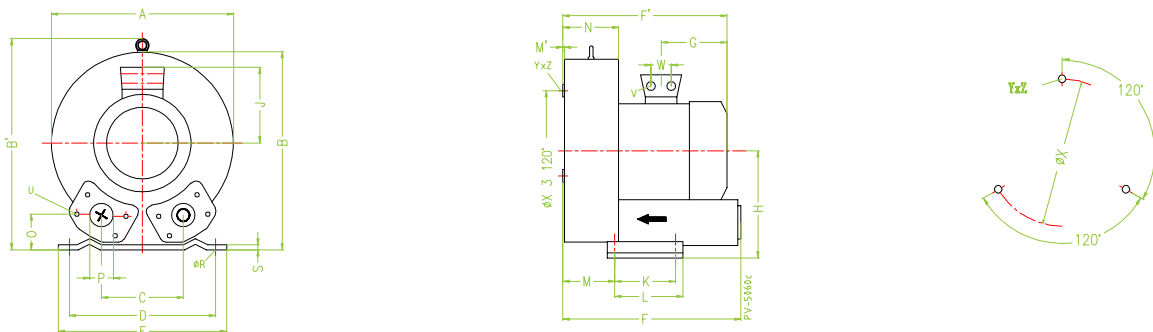

INW 84 H37

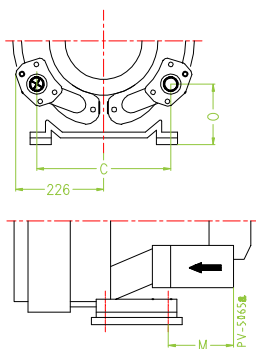

INW 84 H27

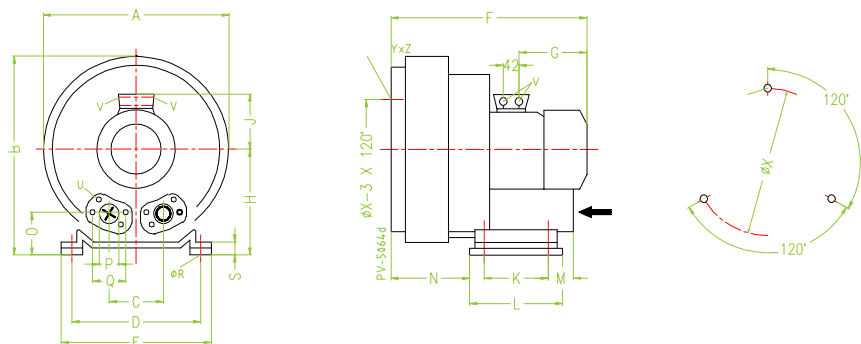

INW 91-95_Одноступенчатые компрессоры и насосы

Размеры

страница 1 из 2

серія	A	A'	B	B'	B ₁	C	C'	D	E	F	F'	F''	G	H	H'	J	K	L	M	M'
INW 91 H07	550	-	569	-	55	207	15	360	414	525	644	605	268	300	-	167	533	-	39	-
INW 91 H17, H37		-		-						611			345		-	197		-		-
INW 93 H07		-		-						563	663	624	490		-	167		-		-
INW 93 H17, H37		-		-						648			345		-	197		-		-
INW 94 H27, H37	615		657		16	207	15	360	415	752	786		345	350		197	533		39	
INW 95 H27, H37	610		732			307		490	526	1180	848	578	291							

серія	N	N'	O	øP	Q	øR	S	T	U	V	W	øX	Y+Z	X - отверстие
INW 91 H07	89	-	93	100	150	15	22	-	M12 x 35	4 x M32 x 1,5	42	490	M12 x 30	0°/120°/240°
INW 91 H17, H37		-						-		4 x M40 x 1,5	54			
INW 93 H07	127	-						-		4 x M32 x 1,5	42			
INW 93 H17, H37		-						-		4 x M40 x 1,5	54			
INW 94 H27, H37	230		150	100	140	15	71		M12 x 35	4 x M40 x 1,5	54	490	M12 x 30	120°/60°/60°
INW 95 H27, H37				219	201		58		M8 x 40	4 x M40 x 1,5	54		M12 x 10.5	

INW 91-95_Одноступенчатые компрессоры и насосы ИНВ

Размеры

страница 2 из 2

INW 91 > INW 93

INW 94

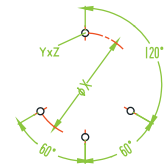
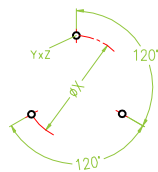
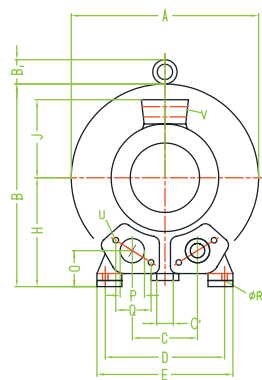
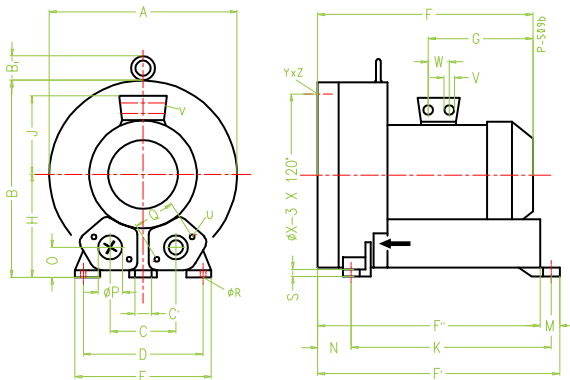

INW 95

